

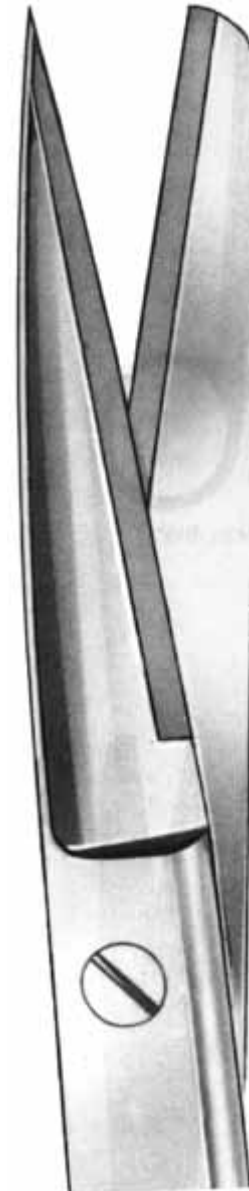

- Eingesetzte TUNGSTENCUT-Einlagen aus extrem harter Wolframlegierung
- TUNGSTENCUT Inserts of extremely hard Tungsten Carbide alloy
- Filos insertados TUNGSTENCUT, una aleación dura de carburo de tungsteno
- Les plaquettes insérées TUNGSTENCUT sont en alliage très dur, le carbure de tungstène



- Instrumente mit Hartmetalleinsatz in Maul oder Schneide
- Instruments with Tungsten Carbide plates or cutting edges
- Instrumentos con boca o corte de carburo de tungsteno
- instruments à mors ou lames en carbure de tungstene



- Absolut präziser Operationsschnitt
- Professioneller Hohlschliff
- Hervorragende Schnitthaltigkeit
- Cut cleanly and precisely
- Professionally ground blades, long service life
- Controlled smooth action
- Corte de máxima agudeza
- Filo duradero garantizado
- Accionamiento suave, corte exacto
- Coupe optimale
- Garantie d'un tranchant toujours parfait
- Maniement souple



12-1000 11.5 cm, 4½"

51



12-1001 11.5 cm, 4½"



12-1020 14 cm, 5½"
12-1022 16 cm, 6¼"
12-1024 18 cm, 7"

51



12-1021 14 cm, 5½"
12-1023 16 cm, 6¼"
12-1025 18 cm, 7"



12-1040 14 cm, 5½"
12-1042 16 cm, 6¼"
12-1044 18 cm, 7"



12-1041 14 cm, 5½"
12-1043 16 cm, 6¼"
12-1045 18 cm, 7"



12-1060 14 cm, 5½"
12-1062 16 cm, 6¼"
12-1064 18 cm, 7"



12-1061 14 cm, 5½"
12-1063 16 cm, 6¼"
12-1065 18 cm, 7"



SIMS
12-1090 23 cm, 9"



SIMS
12-1092 23 cm, 9"



SIMS
12-1094 23 cm, 9"

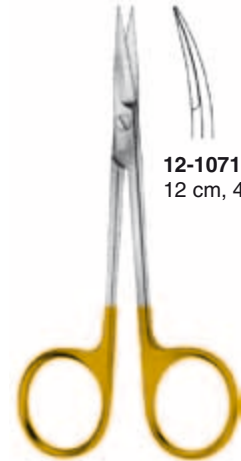

12-1071
12 cm, 4 3/4"

WAGNER
12-1070
12 cm, 4 3/4"



SIMS
12-1091 23 cm, 9"



SIMS
12-1093 23 cm, 9"



SIMS
12-1095 23 cm, 9"



12-1011
16 cm, 6 1/4"

KELLY
12-1010 16 cm, 6 1/4"



LEXER
12-1100 16 cm, 6¼"
12-1104 21 cm, 8½"



MAYO
12-1120 14.5 cm, 5¾"
12-1122 17 cm, 6¾"
12-1124 23 cm, 9" 



MAYO-STILLE
 12-1140 14.5 cm, 5¾"
12-1142 17 cm, 6¾"



LEXER
12-1101 16 cm, 6¼"
12-1103 16 cm, 6¼", del.
12-1105 21 cm, 8½"



MAYO
12-1121 14.5 cm, 5¾"
12-1123 17 cm, 6¾"
12-1125 23 cm, 9" 



MAYO-STILLE
 12-1141 14.5 cm, 5¾"
12-1143 17 cm, 6¾"



MINI-METZENBAUM
12-1200 11.5 cm, 4½"



MINI-METZENBAUM
12-1201 11.5 cm, 4½"



RAGNELL
12-1007 12 cm, 4¾"



TOENNIS ADSON
12-1205 18 cm, 7"

sehr schlank
very delicate
muy delicate
très fin

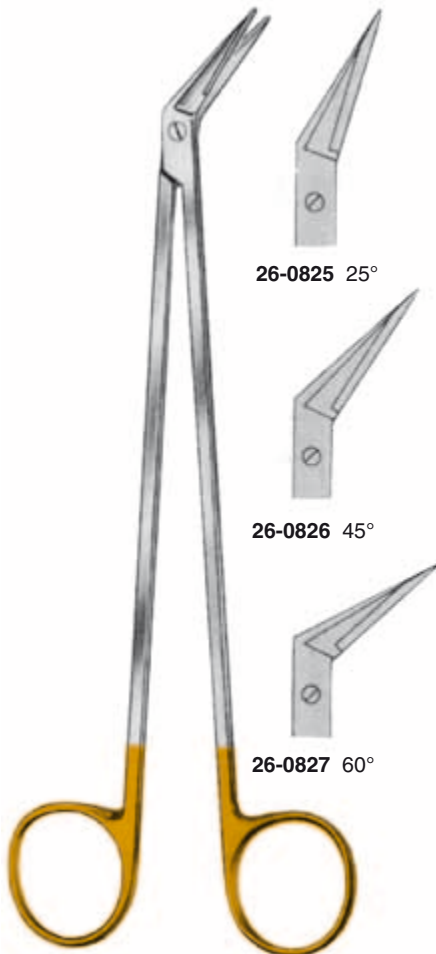

26-0825 25°

26-0826 45°

26-0827 60°

POTTS-SMITH

- 26-0825** 19 cm, 7½", 25°
- 26-0826** 19 cm, 7½", 45°
- 26-0827** 19 cm, 7½", 60°

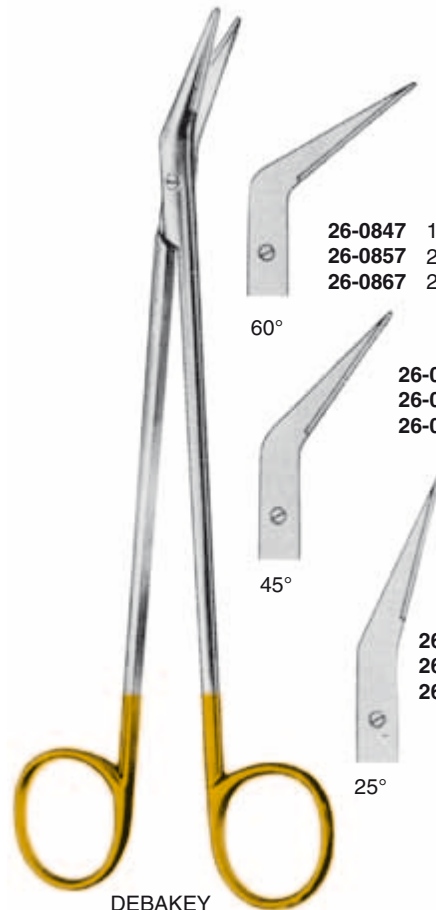

- 26-0847** 17 cm, 6¾"
- 26-0857** 23 cm, 9"
- 26-0867** 28 cm, 11"

60°

- 26-0846** 17 cm, 6¾"
- 26-0856** 23 cm, 9"
- 26-0866** 28 cm, 11"

45°

- 26-0845** 17 cm, 6¾"
- 26-0855** 23 cm, 9"
- 26-0865** 28 cm, 11"

25°

DEBAKEY



METZENBAUM



standard-normal
normal-standard



schlank- delicate
delicada-fin



sehr schlank-very delicate
muy delicada-trés fin

14.5 cm, 5¾"	12-1210	12-1212	12-1214
18 cm, 7"	12-1220	12-1222	12-1224
20 cm, 8"	12-1230	12-1232	12-1234



standard-normal
normal-standard

schlank- delicate
delicada-fin

sehr schlank-very delicate
muy delicada-trés fin

14.5 cm, 5¾"	12-1211	12-1213	12-1215
18 cm, 7"	12-1221	12-1223	12-1225
20 cm, 8"	12-1231	12-1233	12-1235

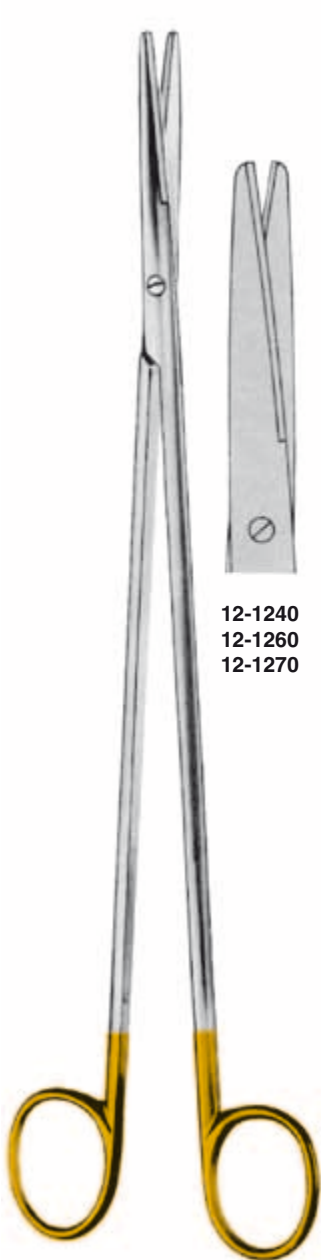

12-1240
12-1260
12-1270
12-1242
12-1262
12-1272
12-1244
12-1280
12-1282

NELSON METZENBAUM

standard-normal-normal-standard

- 12-1240 23 cm, 9"
- 12-1260 25 cm, 10"
- 12-1270 28 cm, 11"
- 12-1280 30 cm, 12"

schlank-delicate-delicada-fin

- 12-1242 23 cm, 9"
- 12-1262 25 cm, 10"
- 12-1272 28 cm, 11"
- 12-1282 30 cm, 12"

sehr schlank-very delicate-much delicada-trés fin

- 12-1244 23 cm, 9"

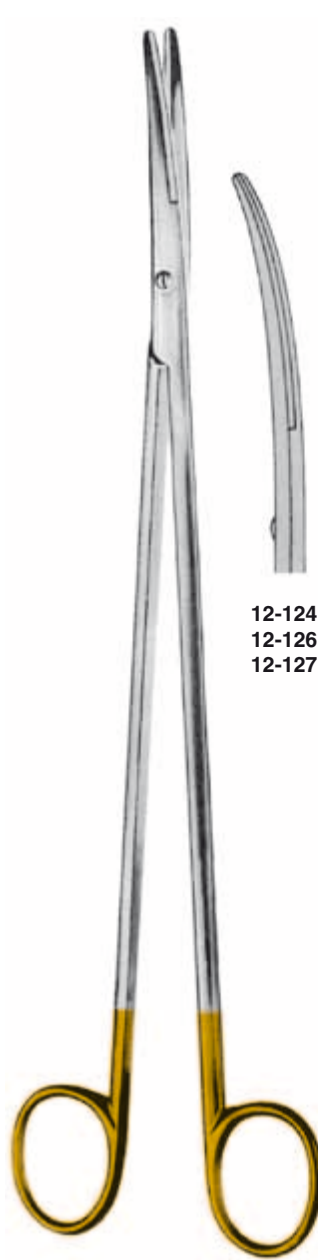

12-1241
12-1261
12-1271
12-1243
12-1263
12-1273
12-1245
12-1281
12-1283

NELSON METZENBAUM

standard-normal-normal-standard

- 12-1241 23 cm, 9"
- 12-1261 25 cm, 10"
- 12-1271 28 cm, 11"
- 12-1281 30 cm, 12"

schlank-delicate-delicada-fin

- 12-1243 23 cm, 9"
- 12-1263 25 cm, 10"
- 12-1273 28 cm, 11"
- 12-1283 30 cm, 12"

sehr schlank-very delicate-much delicada-trés fin

- 12-1245 23 cm, 9"



GOLDMANN-FOX
12-1004 13 cm, 5"

GOLDMANN-FOX
12-1005 13 cm, 5"



UNIVERSAL
12-1099 12.5 cm, 5"



LISTER
12-1401 14 cm, 5½"
12-1403 18 cm, 7"



BRUNS
12-1413 24 cm, 9½"

SCHREIBER SUPER CUT SCISSORS

Anti slip serration

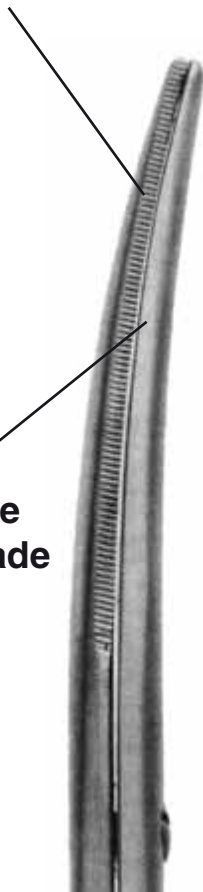

Razor edge
cutting blade

- Extremely sharp razor cutting edge
- Anti slip serration
- Smooth and precise cut
- Long service life (hardness 55 HRC)
- Best performance for high demands
- not suitable for hard materials (wires)

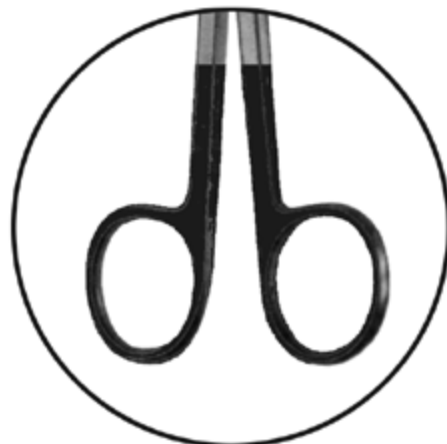

Identification: two black rings



IRIS SCISSORS STRAIGHT
12-2000-RS 9 cm, 3 1/2"
12-2010-RS 11.5 cm, 4 1/2"



IRIS SCISSORS CURVED
12-2001-RS 9 cm, 3 1/2"
12-2011-RS 11.5 cm, 4 1/2"



IRIS SCISSORS, STR.
50-4152-RS 9.0 cm, 3 1/2"
12-2020-RS 10.5 cm, 4 1/8"
12-2022-RS 11.5 cm, 4 1/2"



IRIS SCISSORS CVD.
50-4153-RS 9.0 cm, 3 1/2"
12-2021-RS 10.5 cm, 4 1/8"
12-2023-RS 11.5 cm, 4 1/2"



KELLY STRAIGHT
12-2070-RS 17.5 cm, 6 3/4"



KELLY CURVED
12-2071-RS 17.5 cm, 6 3/4"



GOLDMAN-FOX STRAIGHT
12-2076-RS 13 cm, 5"



GOLDMAN-FOX CURVED
12-2077-RS 13 cm, 5"



OP SCISSORS STRAIGHT
12-2104-RS 14 cm, 5 1/2"



OP SCISSORS CURVED
12-2105-RS 14 cm, 5 1/2"



LEXER STRAIGHT
12-2210-RS 16 cm, 6 1/4"



LEXER CURVED
12-2211-RS 16 cm, 6 1/4"



MAYO SCISSORS STRAIGHT
12-2230-RS 14 cm, 5 1/2"
12-2234-RS 17 cm, 7"
12-2238-RS 23 cm, 9"



MAYO SCISSORS CURVED
12-2231-RS 14 cm, 5 1/2"
12-2235-RS 17 cm, 7"
12-2239-RS 23 cm, 9"



MAYO STILLE STRAIGHT
12-2250-RS 14 cm, 5 1/2"
12-2254-RS 17 cm, 7"



MAYO STILLE CURVED
12-2251-RS 14 cm, 5 1/2"
12-2255-RS 17 cm, 7"



METZENBAUM STRAIGHT

- 12-2406-RS** 13 cm, del., 5"
- 12-2410-RS** 12 cm, 4 3/4"
- 12-2460-RS** 14.5 cm, 5 1/2"
- 12-2462-RS** 18 cm, 7"
- 12-2464-RS** 20 cm, 8"
- 12-2466-RS** 23 cm, 9"



METZENBAUM CURVED

- 12-2407-RS** 13 cm, del., 5"
- 12-2411-RS** 12 cm, 4 3/4"
- 12-2423-RS** 14.5 cm, del., 5 1/2"
- 12-2461-RS** 14.5 cm, 5 1/2"
- 12-2463-RS** 18 cm, 7"
- 12-2465-RS** 20 cm, 8"
- 12-2467-RS** 23 cm, 9"
- 12-2469-RS** 25 cm, 10"



LISTER BANDAGE SCISSORS

- 12-4213-RS** 14 cm, 5 1/2"
- 12-4215-RS** 18 cm, 7"
- 12-4217-RS** 20 cm, 8"



STEVENS SCISSORS

- 50-4140-RS** 10.5 cm, 4", str.
- 50-4141-RS** 10.5 cm, 4", cvd.

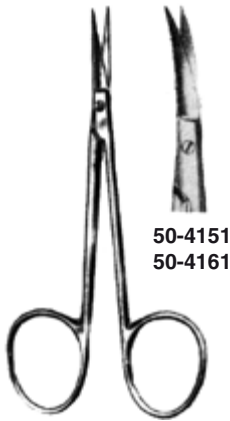

50-4151
50-4161

BONN
 50-4150 9 cm, 3½"
 50-4160 10.5 cm, 4¼"



12-2001 **SI**
12-2003

12-2000 9 cm, 3½"
 12-2002 10 cm, 4" **SI**



12-2425

extra grosse Ringe
 xtra large rings

12-2424 10.5 cm, 4¼"



SI

12-2011

spitz/spitz
 sharp/sharp
 aguda/aguda
 pointu/pointu

12-2010 11.5 cm, 4½"



12-2013

spitz/stumpf
 sharp/blunt
 aguda/roma
 pointu/mousse

12-2012 11.5 cm, 4½"

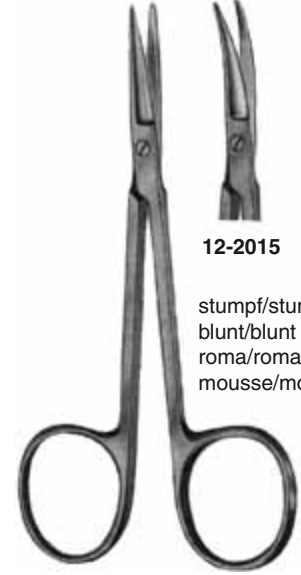

12-2015

stumpf/stumpf
 blunt/blunt
 roma/roma
 mousse/mousse

12-2014 11.5 cm, 4½"

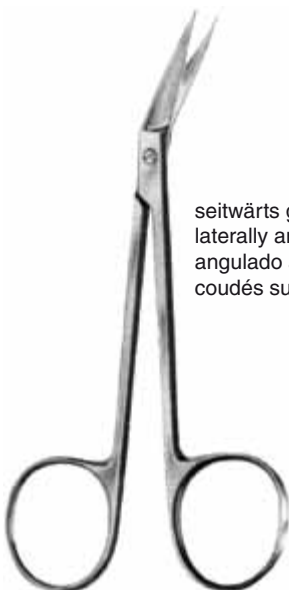

seitwärts gewinkelt
 laterally angled
 angulado al lado
 coudés sur le champs

12-2017 11 cm, 4¼"

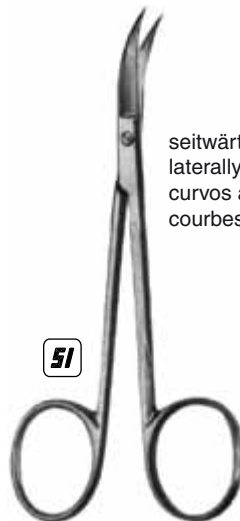

SI

seitwärts gebogen
 laterally curved
 curvos al lado
 courbes sur le champs

12-2019 11 cm, 4¼"

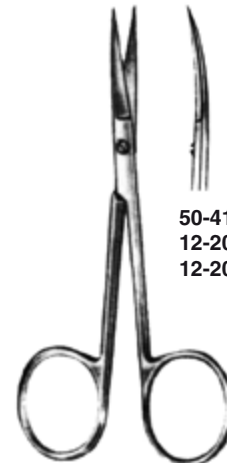

50-4153 9 cm, 3½"
 12-2021 10.5 cm, 4½"
 12-2023 11 cm, 4¼"

50-4152 9 cm, 3½"
 12-2020 10.5 cm, 4½"
 12-2022 11 cm, 4¼"



50-4002

50-4000
10 cm, 4"



50-4004
9 cm, 3½"



50-4020
10 cm, 4"



50-4030
9.5 cm, 3¾"



50-4034
9.5 cm, 3¾"



50-4003

50-4001
10 cm, 4"



50-4005
9 cm, 3½"



50-4022
9.5 cm, 3¾"



50-4031
9.5 cm, 3¾"



50-4035
9.5 cm, 3¾"



50-4040
10.5 cm, 4¼"



50-4041
10.5 cm, 4¼"



50-4043
10.5 cm, 4¼"

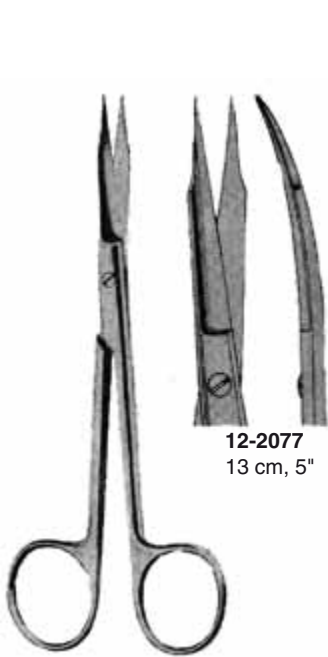

12-2077
13 cm, 5"

GOLDMAN-FOX
12-2076
13 cm, 5"

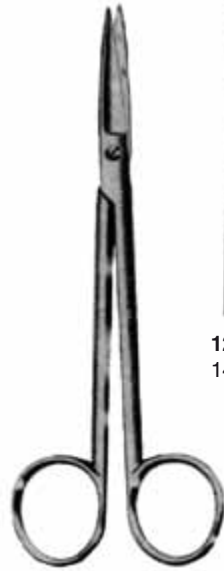

12-2091
14 cm, 5½"

JOSEPH
12-2090
14 cm, 5½"



12-2071 18 cm, 7"
12-2073 16 cm, 6 ½"

KELLY
12-2070 18 cm, 7"
12-2072 16 cm, 6 ½"



12-2095
14cm, 5½"

SANVENERO
12-2094
14cm, 5½"

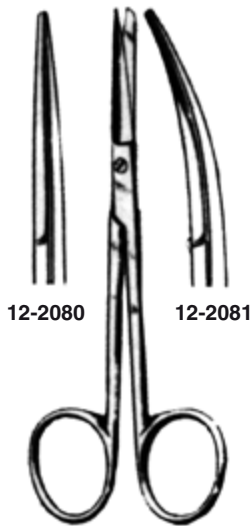

12-2080 **12-2081**

12 cm, 4¾"

spitz/stumpf
sharp /blunt
aguda/roma
pointu/mousse

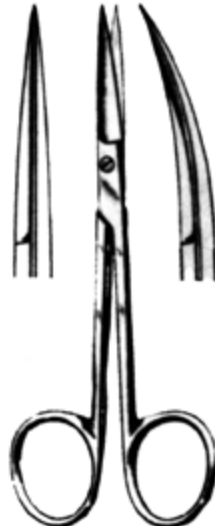

SI **12-2082** 12 cm, 4¾" **12-2083** **SI**
12-2086 13 cm, 5" **12-2087**

spitz/spitz
sharp /sharp
aguda/aguda
pointu/pointu

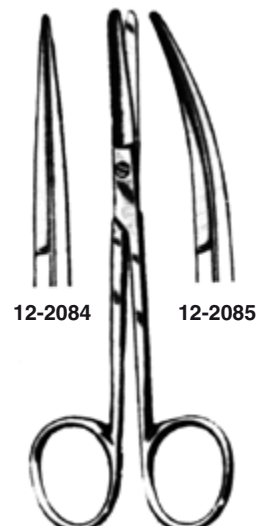

12-2084 **12-2085**

12 cm, 4¾"

stumpf/stumpf
blunt /blunt
roma/roma
mousse/mousse

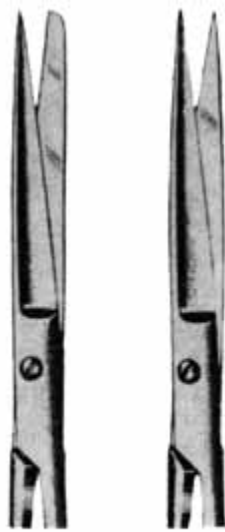

gerade, schlank
straight, delicate
recta, delicada
droit, délicats



gebogen, schlank
curved, delicate
curva, delicada
courbe, délicats

cm in.

13 5

14.5 5½

12-2030

12-2040

12-2050

12-2052

cm in.

13 5

14.5 5½

12-2031

12-2041

12-2051

12-2033

12-2043

12-2053

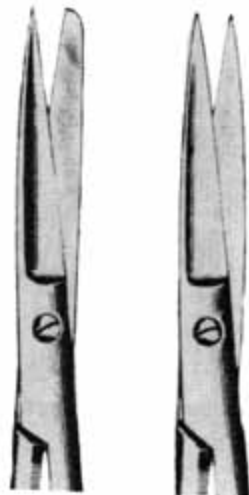

gerade
straight
recta
droit



gebogen
curved
curva
courbe



cm in.

10.5 4¼

11.5 4½

13 5

14.5 5½

15.5 6

16.5 6½

17.5 7

18.5 7¼

20 8

12-2116

12-2136

12-2156

12-2100

12-2120

12-2140

12-2102

12-2122

12-2142

12-2104

12-2124

12-2144

12-2106

12-2126

12-2146

12-2108

12-2128

12-2148

12-2110

12-2130

12-2150

12-2112

12-2132

12-2152

12-2114

12-2134

12-2154

cm in.

10.5 4¼

11.5 4½

13 5

14.5 5½

15.5 6

16.5 6½

17.5 7

18.5 7¼

20 8

12-2117

12-2137

12-2157

12-2101

12-2121

12-2141

12-2103

12-2123

12-2143

12-2105

12-2125

12-2145

12-2107

12-2127

12-2147

12-2109

12-2129

12-2149

12-2111

12-2131

12-2151

12-2113

12-2133

12-2153

12-2115

12-2135

12-2155



51

12-2164 13 cm, 5"
12-2166 14.5 cm, 5½"
12-2168 16.5 cm, 6½"

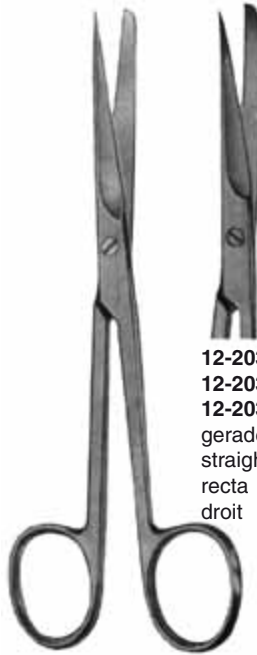

12-2035 14 cm, 5½", sh/sh
12-2037 14 cm, 5½", sh/bl
12-2038 14 cm, 5½", bl/bl
gerade
straight
recta
droit

DEAVER

12-2034 14 cm, 5½", sh/sh
12-2036 14 cm, 5½", sh/bl
12-2038 14 cm, 5½", bl/bl
gerade
straight
recta
droit

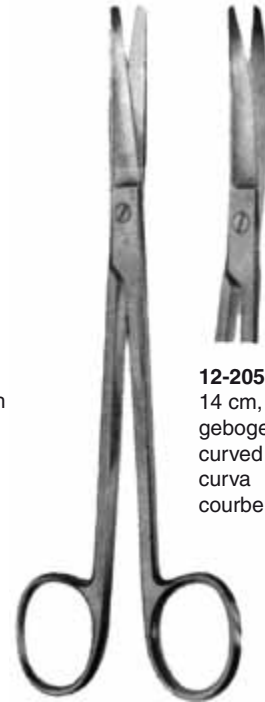

12-2055
14 cm, 5½"
gebogen
curved
curva
courbe

MIXTER

12-2054 15 cm, 6"
gerade
straight
recta
droit



FERGUSON

12-2734 14.5 cm, 5½"
12-2735 18 cm, 7"
12-2736 16 cm, 6¼"



BUSCH

12-2193 13.5 cm, 5¼"
12-2195 16 cm, 6¼"



RICHTER

12-2187 13 cm, 5" sh/bl
12-2189 14.5 cm, 5½" sh/sh
12-2190 14.5 cm, 5½", sh/bl
12-2191 14.5 cm, 5½", sh/sh



MAYO-NOBLE
12-2200
17 cm, 7"



MAYO-NOBLE
12-2201
17 cm, 7"



MAYO-NOBLE-STILLE
12-2206
17 cm, 7"



MAYO-NOBLE-STILLE
12-2207
17 cm, 7"



MAYO OP
12-2228
14 cm, 5½"



12-2229
14 cm, 5½"

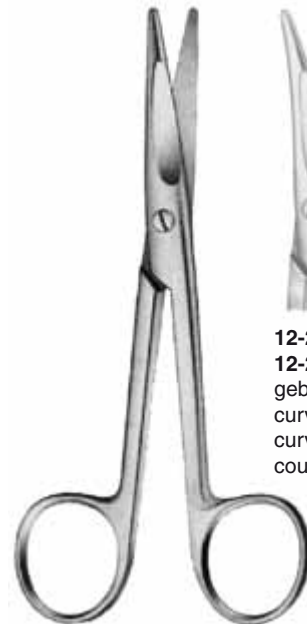

MAYO-STILLE
12-2260 14 cm, 5½"
12-2264 17 cm, 6¾"
mit rundem Blatt
with round blades
con hoja redondo



12-2261 14 cm, 5½"
12-2265 17 cm, 6¾"
gebogen
curved
curva
courbe



cm	in.	LEXER		MAYO		MAYO HARRINGTON	
14.5	5½			12-2230	12-2231		
16	6¼	12-2210	12-2211				
17	6¾			12-2234	12-2235		
19.5	7¾			12-2236	12-2237		
21	8½	12-2214	12-2215	12-2246	12-2247		
23	9			12-2238	12-2239	12-2270	12-2271
28	11					12-2272	12-2273
		gerade straight recta droit	gebogen curved curva courbe	gerade straight recta droit	gebogen curved curva courbe	gerade straight recta droit	gebogen curved curva courbe

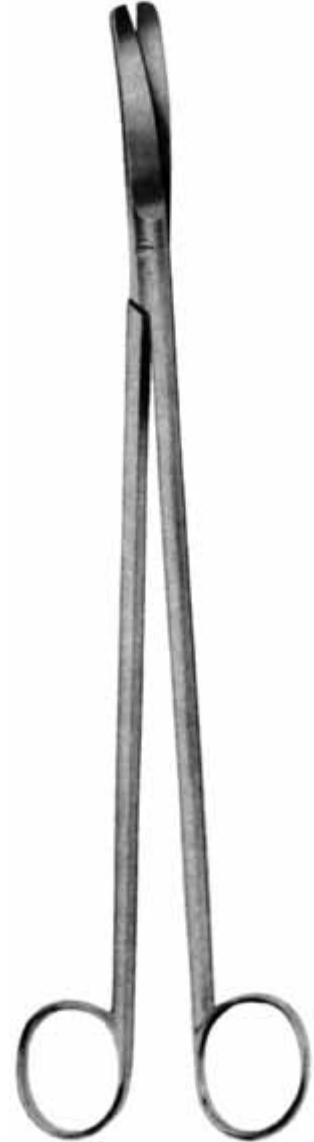

cm	in.	MAYO STILLE		WERTHEIM		WILLAUER	
14.5	5½	12-2250	12-2251	12-2304	12-2305		
17	6¾	12-2254	12-2255				
19.5	7¾	12-2256	12-2257	12-2300	12-2301		
21	8½	12-2258	12-2259				
23	9			12-2302	12-2303		
25	10					25-1370	25-1371
28	11					25-1372	25-1373
30	12					25-1374	25-1375
		gerade straight recta droit	gebogen curved curva courbe	gerade straight recta droit	gebogen curved curva courbe	gerade straight recta droit	gebogen curved curva courbe



THOREK
12-2309 14 cm, 5½"
12-2311 19 cm, 7½"
12-2315 25 cm, 10"



KLINKENBERG-LOTH
12-2325 23 cm, 9"

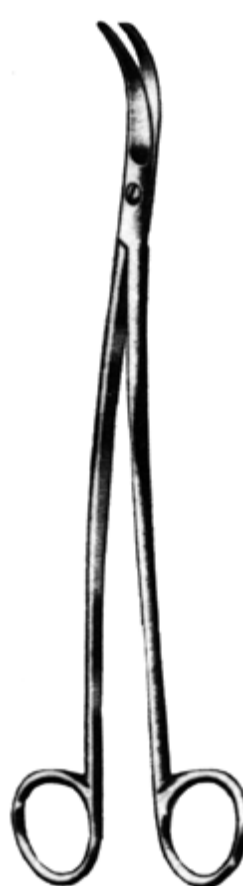

SATINSKY
26-0889 14 cm, 5½"
26-0891 25 cm, 10"



REYNOLDS
12-2341 14.5 cm, 5½"
12-2343 18 cm, 7"
12-2345 20 cm, 8"
12-2347 25 cm, 10"
12-2351
12-2353
12-2355
12-2357
gezahnt
saw edge
dentadas
dentéles



GLASSMANN
12-2441 13 cm, 5"
12-2443 18 cm, 7"



BABY-METZENBAUM
12-2422 14.5 cm, 5½"



12-2423
14.5 cm, 5½"



TOENNIS
12-2450 18 cm, 7"



12-2451
18 cm, 7"



TOENNIS-ADSON (MCINDOE)
12-2455 18 cm, 7"
sehr zart, very delicate,
muy delicada, très fin



12-2570
11 cm, 4½"

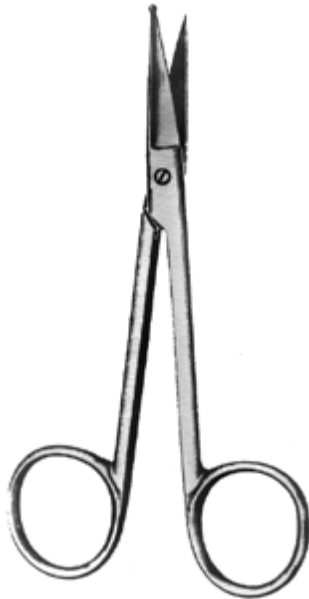

12-2576
11.5 cm, 4¾"



12-2578
14 cm, 5½"



12-2771 11 cm, 4½"
12-2773 13 cm, 5"
12-2775 14 cm, 5½"
 gebogen
 curved
 curva
 courbe

12-2770 11 cm, 4½"
12-2772 13 cm, 5"
12-2774 14 cm, 5½"
 gerade
 straight
 recta
 droit



12-2381
11 cm, 4½"

12-2380
11 cm, 4½"



12-2401
10 cm, 4"

MINI-LEXER
12-2400
10 cm, 4"



BABY DURA
12-2403
11 cm, 4¼"



MINI TOENNIS
12-2405
12 cm, 4½"



METZENBAUM
12-2406 13 cm, 5" **12-2407**
12-2408 15 cm, 6" **12-2409**
gerade gebogen
straight curved
recta curva
droit courbe



12-2411
11.5 cm, 4½"

12-2410
11.5 cm, 4½"

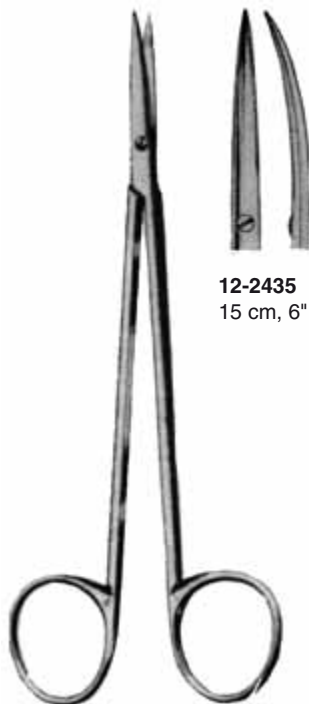

12-2435
15 cm, 6"

WALTON
12-2434
15 cm, 6"





JAMESON
12-2431 15 cm, 6"
12-2433 18 cm, 7"



KILNER
12-3311 12 cm, 4¾"
12-3321 15 cm, 6"
12-3325 18 cm, 7"
12-3327 20 cm, 8"



NELSON-METZENBAUM

cm	in.	1 	2	3	1 	2	3
14.5	5½	12-2460	12-2602	12-2604	12-2461	12-2603	12-2605
18	7	12-2462	12-2612	12-2614	12-2463	12-2613	12-2615
20	8	12-2464	12-2622	12-2624	12-2465	12-2623	12-2625
23	9	12-2466	12-2632	12-2634	12-2467	12-2633	12-2635
25	10	12-2468	12-2642	12-2644	12-2469	12-2643	12-2645
28	11	12-2470	12-2652	12-2654	12-2471	12-2653	12-2655
30	12	12-2472	12-2662	12-2664	12-2473	12-2663	12-2665
36	14¼	12-2476			12-2477		

gerade
straight
recta
droit

gebogen
curved
curva
courbe

- sehr feine Präparierscheren
- very delicate dissecting scissors
- tijeras para preparaciones muy delicadas
- ciseaux à dissection très délicates

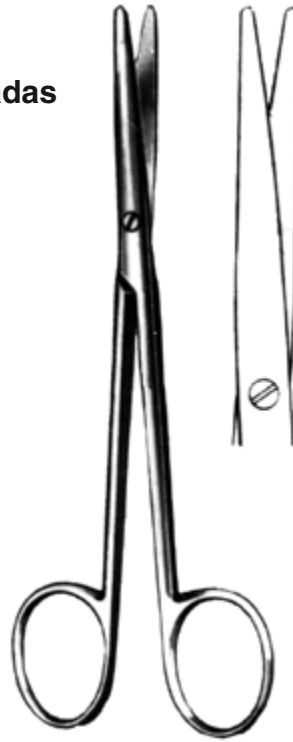

LEXER
 12-2220
 16 cm, 6¼"

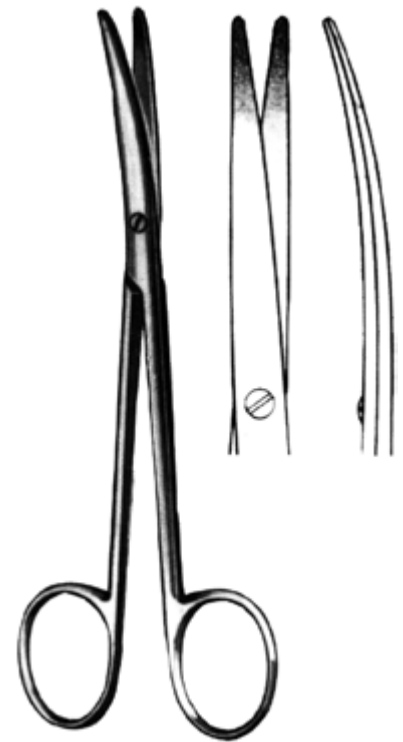

LEXER
 12-2221
 16 cm, 6¼"



METZENBAUM
 12-2422
 14.5 cm, 5½"

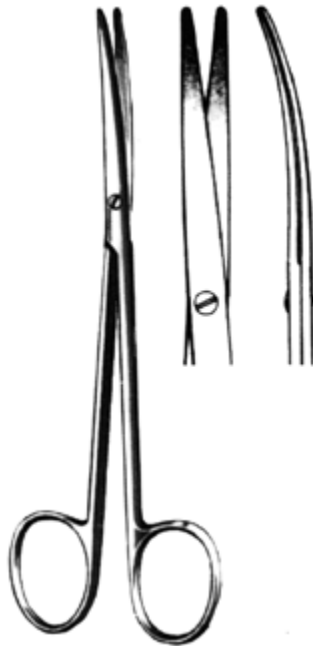

METZENBAUM
 12-2423
 14.5 cm, 5½"

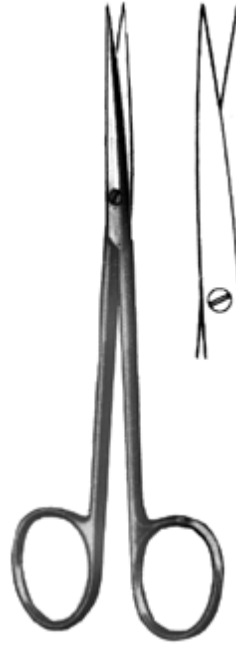

METZENBAUM
 12-2500
 14.5 cm, 5½"

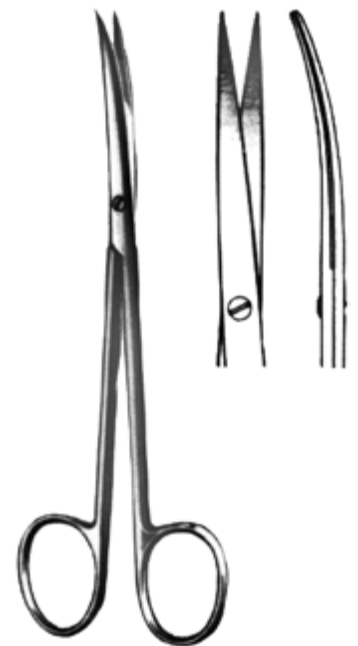

METZENBAUM
 12-2501
 14.5 cm, 5½"

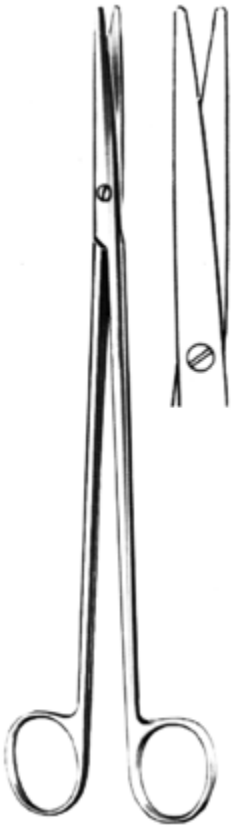

METZENBAUM
12-2482 18 cm, 7"
12-2484 20 cm, 8"
12-2486 23 cm, 9"



METZENBAUM
12-2483 18 cm, 7"
12-2485 20 cm, 8"
12-2487 23 cm, 9"
12-2489 28 cm, 11"



METZENBAUM
12-2502 18 cm, 7"
12-2504 20 cm, 8"
12-2506 23 cm, 9"

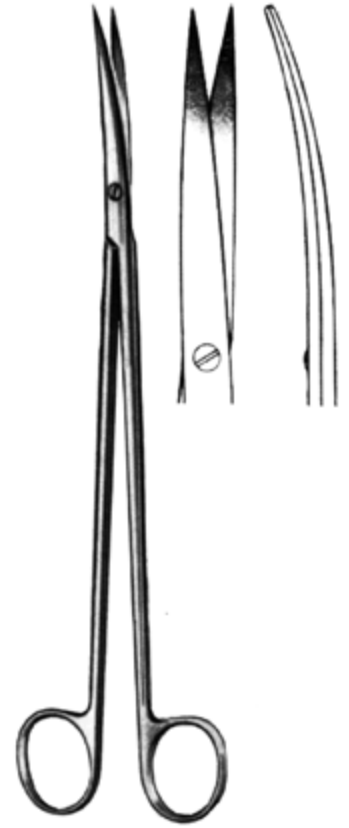

METZENBAUM
12-2503 18 cm, 7"
12-2505 20 cm, 8"
12-2507 23 cm, 9"

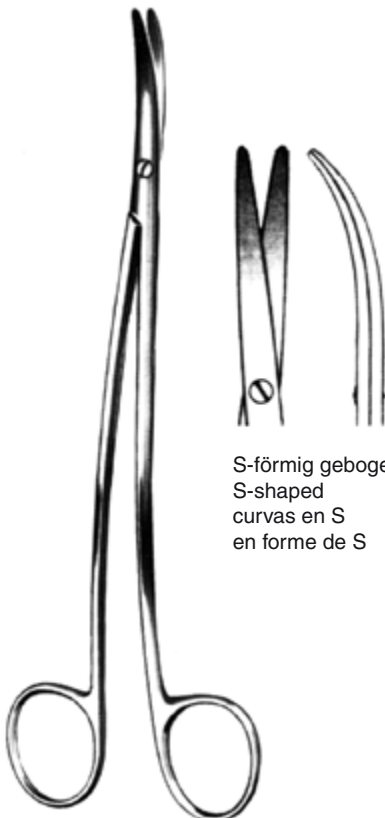

S-förmig gebogen
 S-shaped
 curvas en S
 en forme de S

METZENBAUM-D'ALLAINES
12-2513 18 cm, 7"
12-2515 20 cm, 8"
12-2517 23 cm, 9"

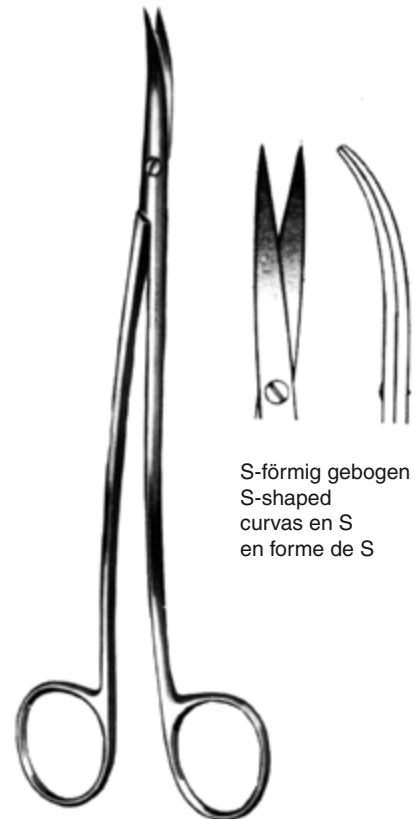

S-förmig gebogen
 S-shaped
 curvas en S
 en forme de S

METZENBAUM
12-2523 18 cm, 7"
12-2525 20 cm, 8"
12-2527 23 cm, 9"



SIMS
12-2700 20 cm, 8"
12-2702 23 cm, 9"



SIMS
12-2710 20 cm, 8"
12-2712 23 cm, 9"



SIMS
12-2720 20 cm, 8"
12-2722 23 cm, 9"



DOYEN
12-2724 16.5 cm, 5½", sh/sh
12-2726 16.5 cm, 5½", bl/bl
12-2728 16.5 cm, 5½", sh/bl
12-2730 18 cm, 7", bl/bl
12-2732 18 cm, 7", sh/bl

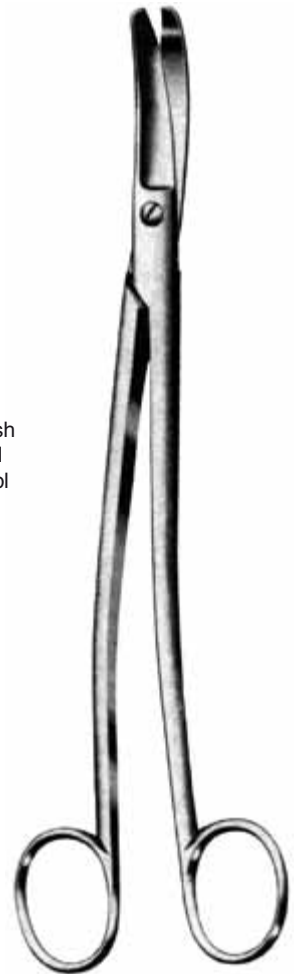

SIEBOLD
12-2741
24.5 cm, 9¾"



SIMS
12-2701 20 cm, 8"
12-2703 23 cm, 9"



SIMS
12-2711 20 cm, 8"
12-2713 23 cm, 9"



SIMS
12-2721 20 cm, 8"
12-2723 23 cm, 9"



DOYEN
12-2725 16,5 cm, 5½", sh/sh
12-2727 16,5 cm, 5½", bl/bl
12-2729 16,5 cm, 5½", sh/bl
12-2731 18 cm, 7", bl/bl
12-2733 18 cm, 7", sh/bl



SI BRAUN
 12-2801 14 cm, 5½"
 12-2803 22 cm, 8¾"



gezahnt
 serrated
 dentadas
 dentelés

WALDMANN
 12-2823 18 cm, 7"



SCHUMACHER
 12-2830 15 cm, 5¾"



USA
 12-2840 10.5 cm, 4¼"



KOENIG
 12-2181 13 cm, 5"
 12-2182 15 cm, 5¾"



12-2760
 21 cm, 8¼"

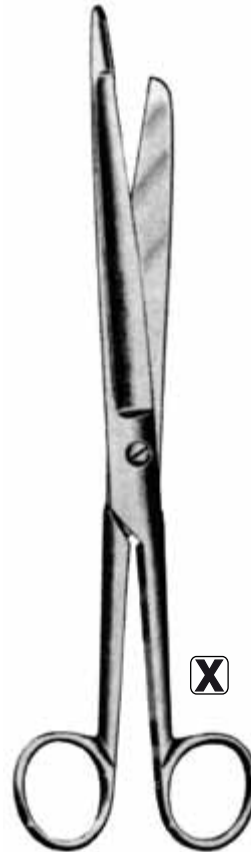

12-2762
 21 cm, 8¼"



12-2764
 21 cm, 8¼"



12-4001
9 cm, 3½"

SPENCER
12-4000
9 cm, 3½"



12-4003
12 cm, 4¾"

SPENCER
12-4002 
12 cm, 4¾"



12-4005 11.5 cm, 4½"

SPENCER
12-4004
11.5 cm, 4½"



LITTAUER
12-4010 
14 cm, 5½"



SPENCER
12-4012
15 cm, 6"



BUCK
12-4014 14 cm, 5½"
12-4018 18 cm, 7"



gezahnt
 serrated
 dentadas
 dentelés

UNIVERSAL
12-4121
 12.5 cm, 5"



MATRIX
12-4123
 11 cm, 4¼"



gezahnt
 serrated
 dentadas
 dentelés

HARVEY
12-4126
 12 cm, 4¾"



gezahnt
 serrated
 dentadas
 dentelés

SMITH
12-4128 16 cm, 6½"
12-2129 18 cm, 7"



spitz
sharp
cortante
tranchant



stumpf
blunt
romo
mousse



BEE-BEE

SI

12-4100 11 cm, 4¼"
12-4110 11 cm, 4¼"*
12-4104 12 cm, 4¾"
12-4114 12 cm, 4¾"*

BEE-BEE

SI

12-4101 11 cm, 4¼"
12-4111 11 cm, 4¼"*
12-4105 12 cm, 4¾"
12-4115 12 cm, 4¾"*

BEE-BEE

12-4102 11 cm, 4¼"
12-4112 11 cm, 4¼"*

BEE-BEE

12-4103 11 cm, 4¼"
12-4113 11 cm, 4¼"*

* gezahnt, serrated edge, dentadas, dentelés

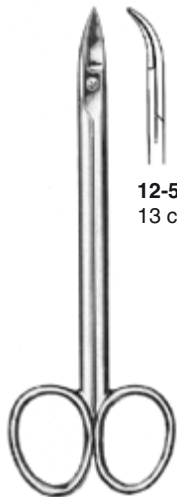

12-5001
13 cm, 5"

QUINBY
12-5000
13cm, 5"



12-4151 9 cm, 3½"
12-4153 11 cm, 4½"
gebogen
curved
curva
courbe

PEDO
12-4150 9 cm, 3½"
12-4152 11 cm, 4½"
gerade
straight
recta
droit



KNOWLES
12-4200
 14 cm, 5½"



LISTER
12-4209 9 cm, 3½"
12-4211 11 cm, 4½"
12-4213 14 cm, 5½"
12-4214 16 cm, 6¼"
12-4215 18 cm, 7"
12-4217 20 cm, 8"
12-4218 18 cm, 7", one big ring
12-4219 20 cm, 8", one big ring



BERGMANN
12-4227
 23 cm, 9"



EXCENTRIC
12-4271 16 cm, 6¼"
12-4273 19 cm, 7½"

gezahnt
 serrated
 dentadas
 dentelés

gezahnt
 serrated
 dentadas
 dentelés



UNIVERSAL BANDAGE
12-4253 14 cm, 5½"
12-4251 18 cm, 7"



gezahnt
 serrated
 dentadas
 dentelés

WALTON
40-0110
 20 cm, 8"



SMITH
12-4228
 15 cm, 6"



SMITH
12-4232
 20 cm, 8"



LANGE
12-4240
 18 cm, 7"



LORENZ
12-4351
 23 cm, 9"

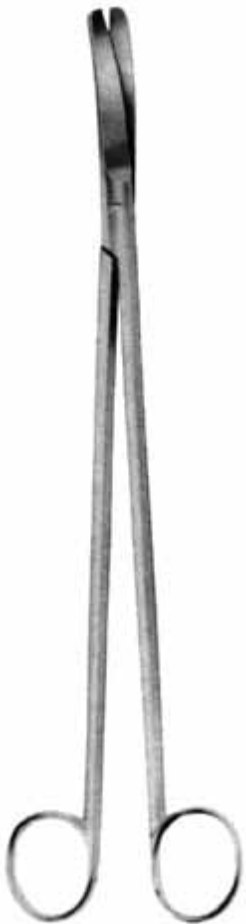

CRAFOORD
25-1300
 30 cm, 12"



JORGENSON
25-1320
 23 cm, 9"



SWEET
25-1330
 22 cm, 8¾"



WILLAUER
25-1370 25 cm, 10" **25-1371**
25-1372 28 cm, 11" **25-1373**
25-1374 30 cm, 12" **25-1375**
 gerade gebogen
 straight curved
 recta curva
 droit courbe



31-0451
 27 cm, 11"

DUBOIS
31-0450 27 cm, 11"



HEGEMANN-DIETRICH

19 cm, 7½"

26-0830 25°

26-0831 45°

26-0832 60°

26-0833 90°

26-0834 125°



POTTS-SMITH

16.5 cm, 6½"

26-0790 25°

26-0791 45°

26-0792 60°



DEBAKEY

17 cm, 6¾"

26-0840 25°

26-0841 45°

26-0842 60°



DE MARTEL

18 cm, 7"

26-0871 50°

aufgewinkelt

angled on flat

angulada

coudés sur le plat

26-0836 125°

mit Führung

with guide

con guia

avec guide

POTTS-SMITH

19 cm, 7½"

26-0820 25°

26-0821 45°

26-0822 60°

DEBAKEY

23 cm, 9"

26-0850 25°

26-0851 45°

26-0852 60°

DEBAKEY

28 cm, 11"

26-0860 25°

26-0861 45°

26-0862 60°



25°



45°



60°



90°



125°

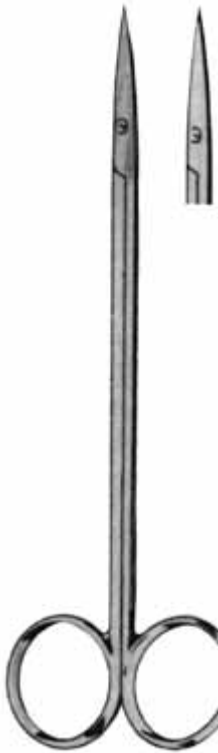

DE MARTEL
26-0800 18 cm, 7"
stumpf
blunt
romo
mousse



DE MARTEL
26-0801 18 cm, 7"
stumpf
blunt
romo
mousse

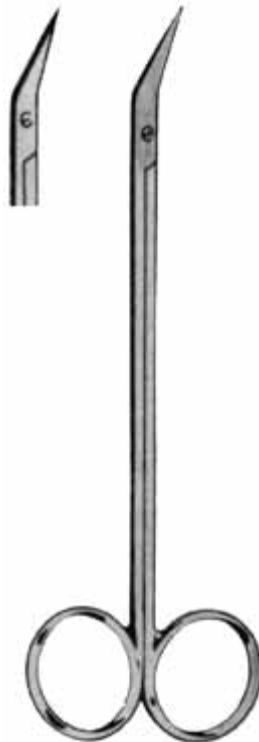

DE MARTEL
26-0803 18 cm, 7"
stumpf
blunt
romo
mousse



DE MARTEL
26-0805 18 cm, 7"
stumpf
blunt
romo
mousse



MILLS
26-0819
22 cm, 9" 60°



DEBAKEY
26-0880 18 cm, 7"
26-0881 18 cm, 7"



CHURCH
26-0910 17 cm, 6 3/4"
26-0916 25 cm, 10"
gerade
straight
recta
droit



LINCOLN
26-0920 17 cm, 6 3/4"
26-0922 25 cm, 10"
gerade
straight
recta
droit

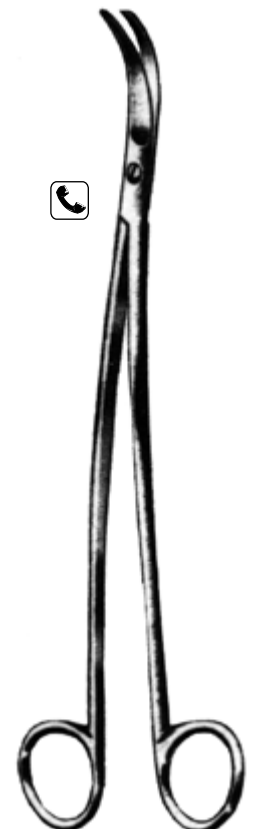

SATINSKY
26-0889 14 cm, 5 1/2"
26-0891 25 cm, 10"



SEUTIN
40-0105
23 cm, 9"



gezahnt
serrated
dentadas
dentelés

WALTON
40-0110
20 cm, 8"



SI

ESMARCH
40-0130 20 cm, 8"



glatt
smooth
liso
lisse

BRUNS
40-0120
24 cm, 9½"



gezahnt
serrated
dentadas
dentelés

SI

BRUNS
40-0121
24 cm, 9½"



gezahnt
serrated
dentadas
dentelés

SI

SI

UNIVERSAL BANDAGE
12-4251
18 cm, 7"



**HEYMANN
44-1400
18 cm, 7"**



**45-1091
19 cm, 7½"
gebogen
curved
curva
courbe**



**MC INDOE
45-1090
19 cm, 7½"**

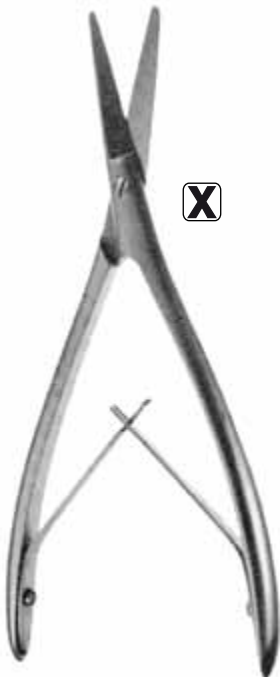

**COTTLE
45-1100
19 cm, 7½"**



**COTTLE
45-1101
19 cm, 7½"**

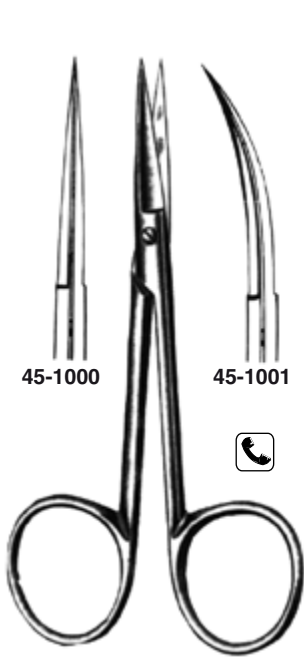

45-1000

45-1001



SEALY
11 cm, 4½"

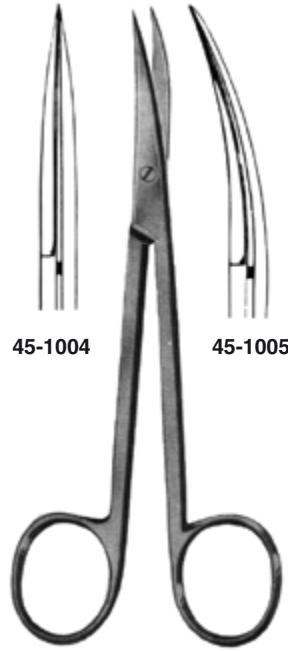

45-1004

45-1005

KILNER
12 cm, 4¾"

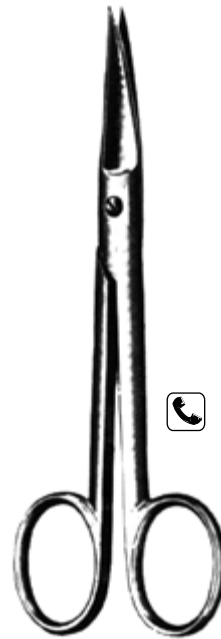

CONVERSE
45-1007
14 cm, 5½"



AUFRICHT
45-1010
15 cm, 6"



45-1021
15 cm, 6"



AUFRICHT
45-1020
15 cm, 6"



45-1025
15 cm, 6"



AUFRICHT
45-1024
15 cm, 6"

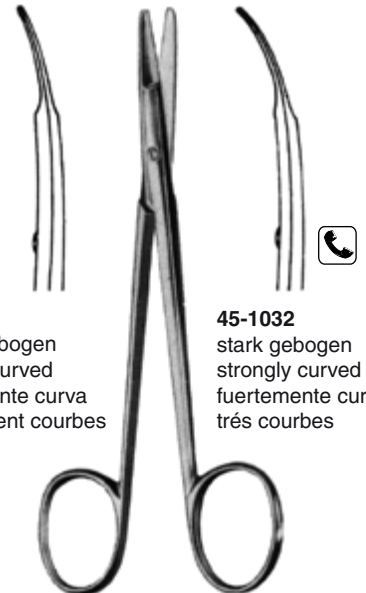

45-1031
leicht gebogen
slightly curved
ligeramente curva
légèrement courbes

45-1032
stark gebogen
strongly curved
fuertemente curva
trés courbes



RAGNELL
45-1030 12.5 cm, 4¾"
gerade
straight
recta
droit



BROPHY
45-1040
14.5 cm, 5½"

45-1041
14.5 cm, 5½"



BROWN
45-1044
14.5 cm, ½"

45-1045
14.5 cm, ½"



BROWN-MODIFIED
45-1046 14.5 cm, 5½"
gerade
straight
recta
droit



45-1047
gebogen
curved
curva
courbe



LITTLER
45-1070
12 cm, 4¾"



FOMON
45-1050
13 cm, 5¼"

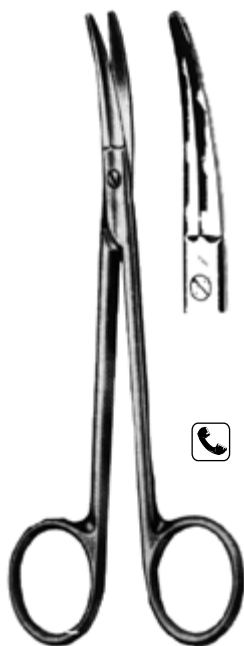

FOMON
45-1053
13 cm, 5¼"



FOMON
45-1057
14.5 cm, 5½"



COTTLE
45-1060
15 cm, 5½"



COTTLE-BULLDOG
45-1067
11 cm, 4¼"

12

Ed. 5.1 06/2011

NAGELSCHEREN
NAIL SCISSORS
TIJERAS PARA CORTA UNAS
CISEAUX POUR ONGLES

SCHREIBER® INSTRUMENTE



gezahnt
 serrated
 dentadas
 dentelés

KOENIG
12-2181 13 cm, 5"
12-2182 15 cm, 6"



SYSTRUNK
12-2284
 13 cm, 5¼"



46-1101 9.5 cm, 3¾"
46-1115 10.5 cm, 4¼"
46-1117 11 cm, 4½"

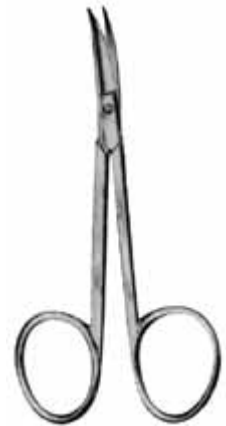

46-1131
 8.5 cm, 3½"
 für Babies
 for babies
 para bebés
 pour bébés

51

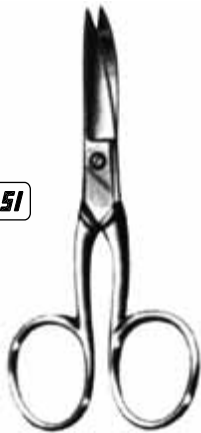

46-1110 9 cm, 3½"
46-1112 10.5 cm, 4½"
 gerade
 straight
 recta
 droit



46-1111
46-1113
 gebogen
 curved
 curva
 courbe

46-1120 9 cm, 3½"
46-1122 10.5 cm, 4½"
 gerade
 straight
 recta
 droit



46-1121
46-1123
 gebogen
 curved
 curva
 courbe



46-1124 10.5 cm, 4½"
 gerade
 straight
 recta
 droit

46-1125
 gebogen
 curved
 curva
 courbe

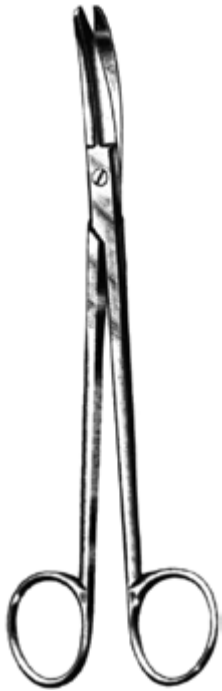

BOETTCHER
47-1001
18 cm, 7"



47-1005
17 cm, 6¾"
gezahnt
serrated
dentadas
dentalés



DEAN
47-1003
17 cm, 6¾"



LILLY
47-1007
19 cm, 7½"



GOOD
47-1011
19 cm, 7½"



gezahnte Spitze
serrated tip
punta dentadas
pointe dentalés

GOOD
47-1013
19 cm, 7½"



PRINCE
47-1021
17.5 cm, 6¾"



50-4100
 spitz/spitz
 sharp/sharp
 aguda/aguda
 pointu/pointu

50-4102
 spitz/stumpf
 sharp/blunt
 aguda/roma
 pointu/mousse

KNAPP
 10 cm, 4"



50-4101
 spitz/spitz
 sharp/sharp
 aguda/aguda
 pointu/pointu

50-4103
 spitz/stumpf
 sharp/blunt
 aguda/roma
 pointu/mousse

KNAPP
 10 cm, 4"

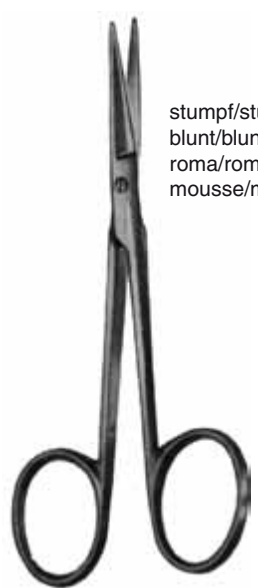

stumpf/stumpf
 blunt/blunt
 roma/roma
 mousse/mousse

KNAPP
50-4104 10 cm, 4"



stumpf/stumpf
 blunt/blunt
 roma/roma
 mousse/mousse

KNAPP
50-4105 10 cm, 4"



STRABISMUS
50-4120 11 cm, 4½"



STRABISMUS
50-4121 11 cm, 4½"



STEVENS
50-4138 10.5 cm, 4¼"
 spitz
 sharp
 aguda
 pointu

50-4140
 stumpf
 blunt
 roma
 mousse



STEVENS
50-4139 10.5 cm, 4¼"
 spitz
 sharp
 aguda
 pointu

50-4141
 stumpf
 blunt
 roma
 mousse

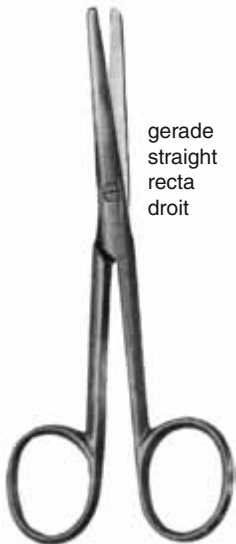

gerade
 straight
 recta
 droit

LANDOLT
50-4210
 12 cm, 4¾"



leicht gebogen
 slightly curved
 curva débil
 coube léger

LANDOLT
50-4211
 12 cm, 4¾"



mittel gebogen
 medium curved
 curva medio
 courbe moyen

LANDOLT
50-4215
 12 cm, 4¾"

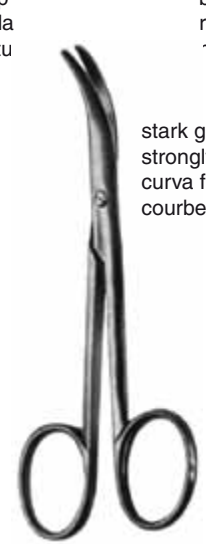

stark gebogen
 strongly curved
 curva fuerte
 courbe fort

LANDOLT
50-4213
 12 cm, 4¾"



50-4151
9 cm, 3½"

BONN
50-4150
9 cm, 3½"
short blade



50-4153
9 cm, 3½"

IRIS
50-4152
9 cm, 3½"

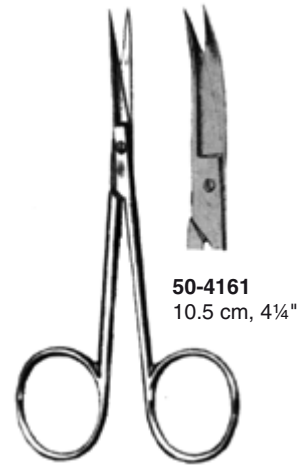

50-4161
10.5 cm, 4¼"

IRIS
50-4160
10.5 cm, 4¼"
sehr zart
very delicate
muy delicada
très fin



WILMER
50-4341
10 cm, 4"



MILLER
21-1901
17 cm, 6¾"



PRATT
21-1903
21 cm, 8½"



gezahnt
serrated
dentadas
dentelés

MARTIN CARTILAGE
41-1901
20 cm, 8"



gezahnte schneiden
serrated edges

STRELI
12-2319
22 cm, 9"



RESANO
12-2317 25 cm, 10", sh/bl, 25°
12-2320 25 cm, 10", bl/bl, 25°
12-2322 25 cm, 10", sh/bl, 15°



STRULLY
12-2913
22 cm, 8½"



SCHMIEDEN
12-2903
17 cm, 6¾"



DANDY
12-2920 17 cm, 6¾"
12-2922 19 cm, 7½"



12-5041
12 cm, 4¾"

WAGNER
12-5040
12 cm, 4¾"

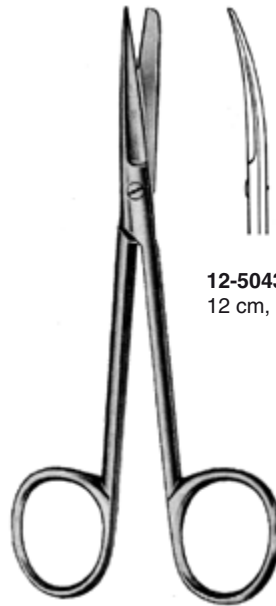

12-5043
12 cm, 4¾"

WAGNER
12-5042
12 cm, 4¾"

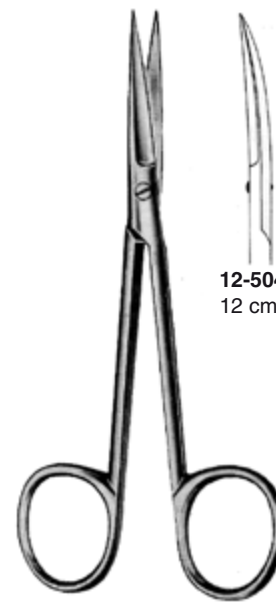

12-5045
12 cm, 4¾"

WAGNER
12-5044
12 cm, 4¾"

1 Schneide gezahnt
1 serrated blade

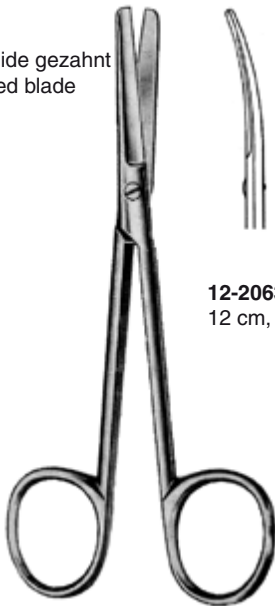

12-2063
12 cm, 4¾"

WAGNER
12-2062
12 cm, 4¾"

1 Schneide gezahnt
1 serrated blade

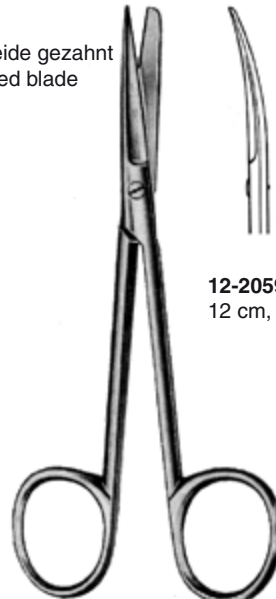

12-2059
12 cm, 4¾"

WAGNER
12-2058
12 cm, 4¾"

1 Schneide gezahnt
1 serrated blade

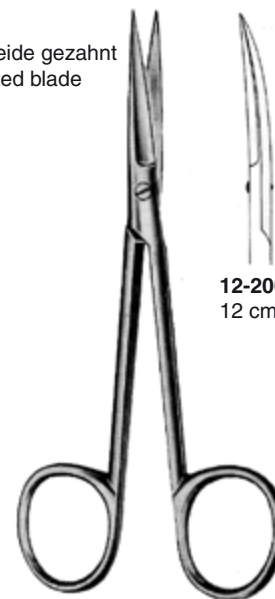

12-2061
12 cm, 4¾"

WAGNER
12-2060
12 cm, 4¾"

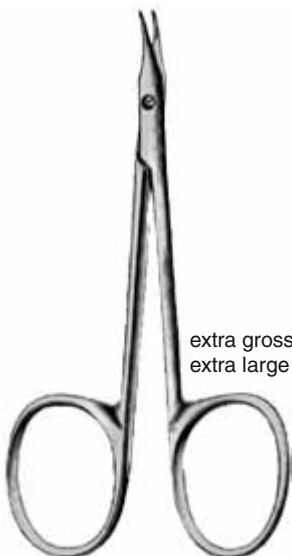

extra grosse Ringe
extra large rings

GRADDLE
12-2427
10 cm, 4"



FMH WIRE SCISSORS
12-4130 11 cm, 4½"
12-4132 12 cm, 4¾"



WHITE DOG TOE NAIL
46-3000
11 cm, 4½"